

INSTALLATIONSANWEISUNG

Gera 9 4,98 x 4,98 m, 44 mm

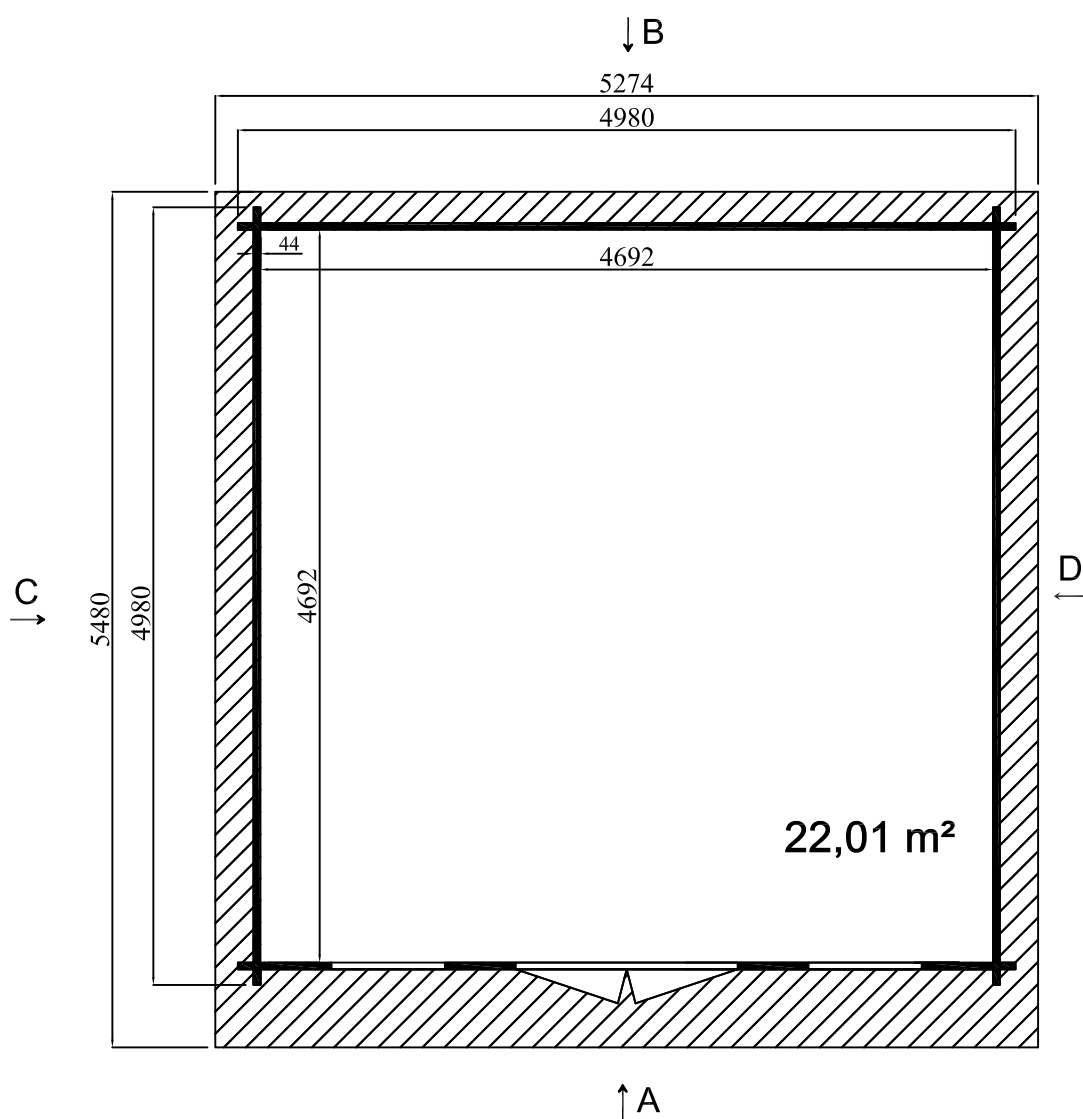

A

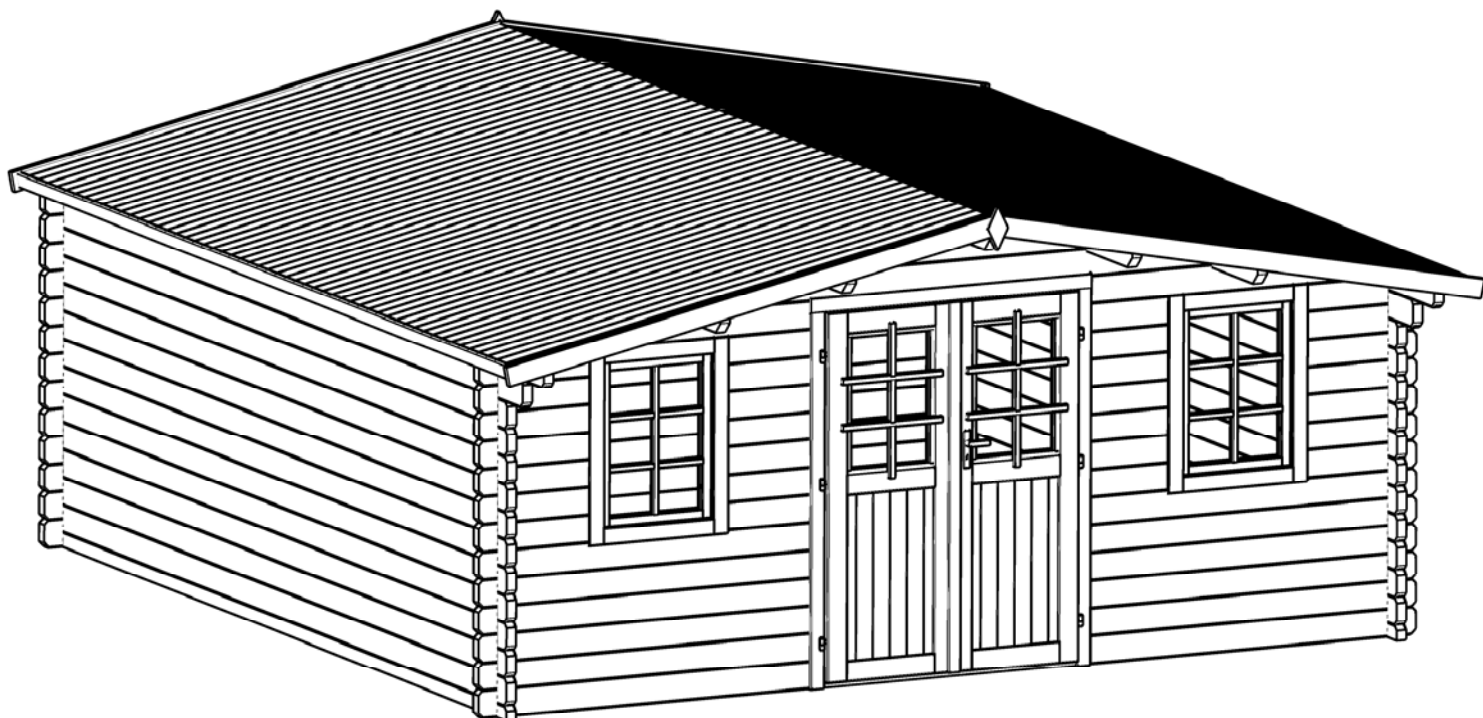
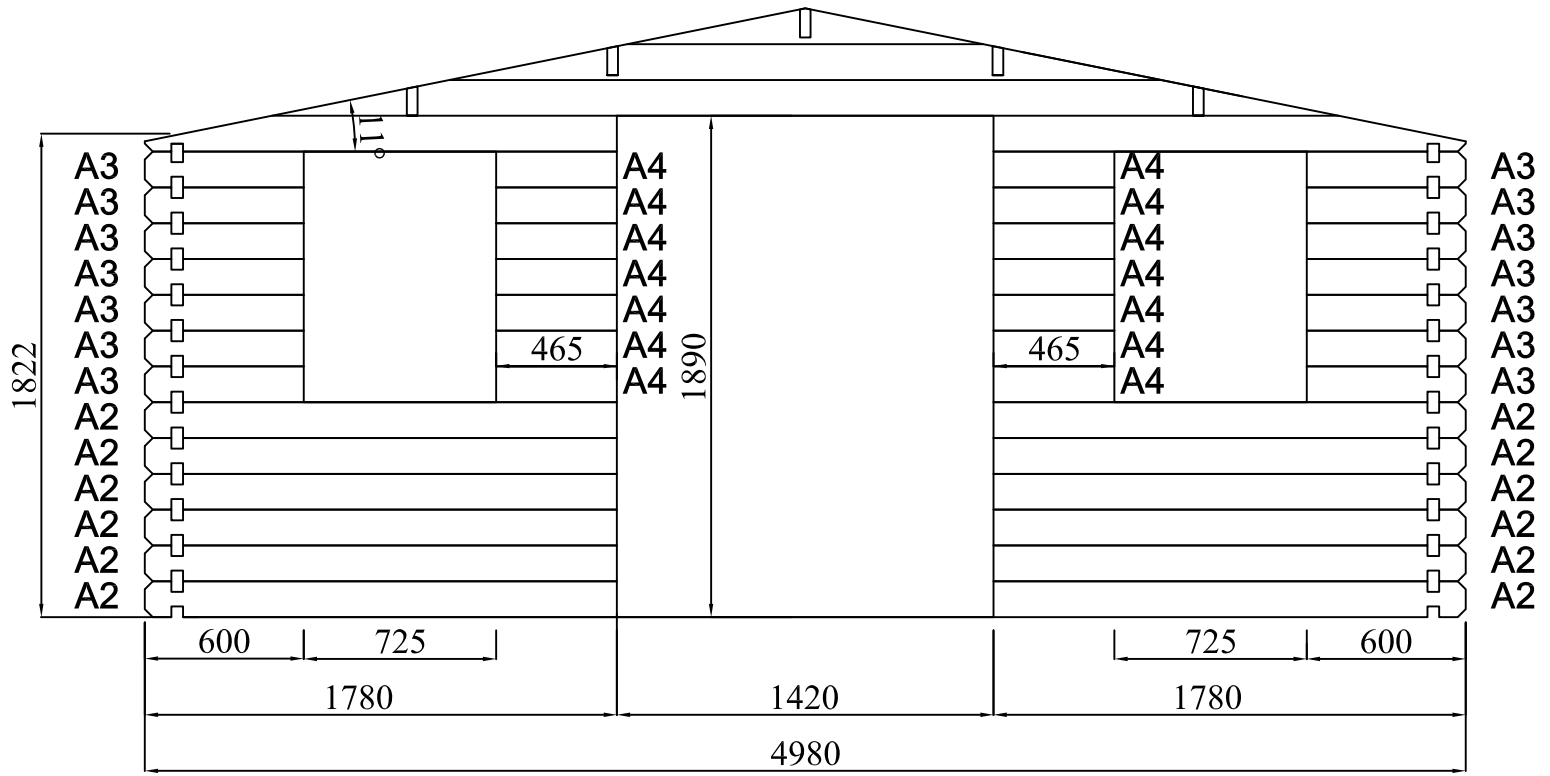

B

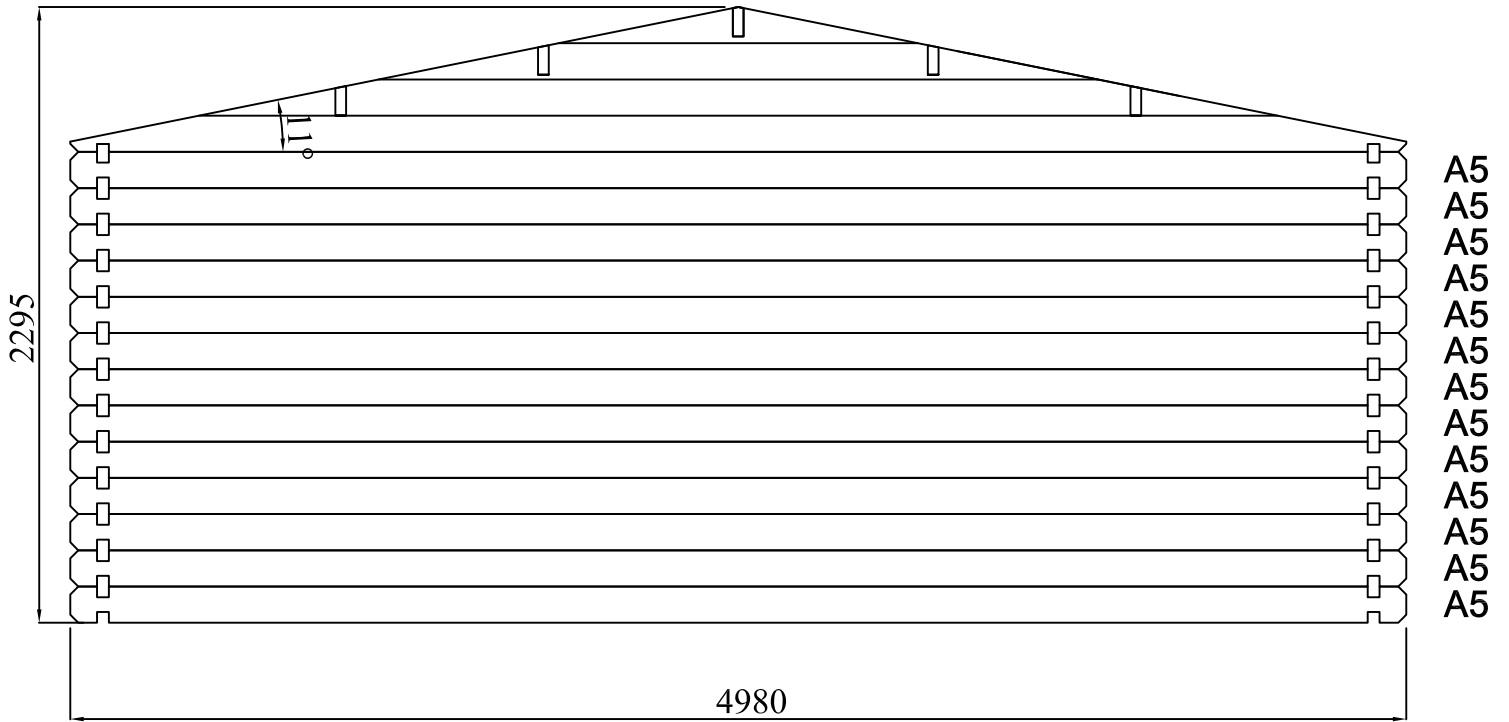



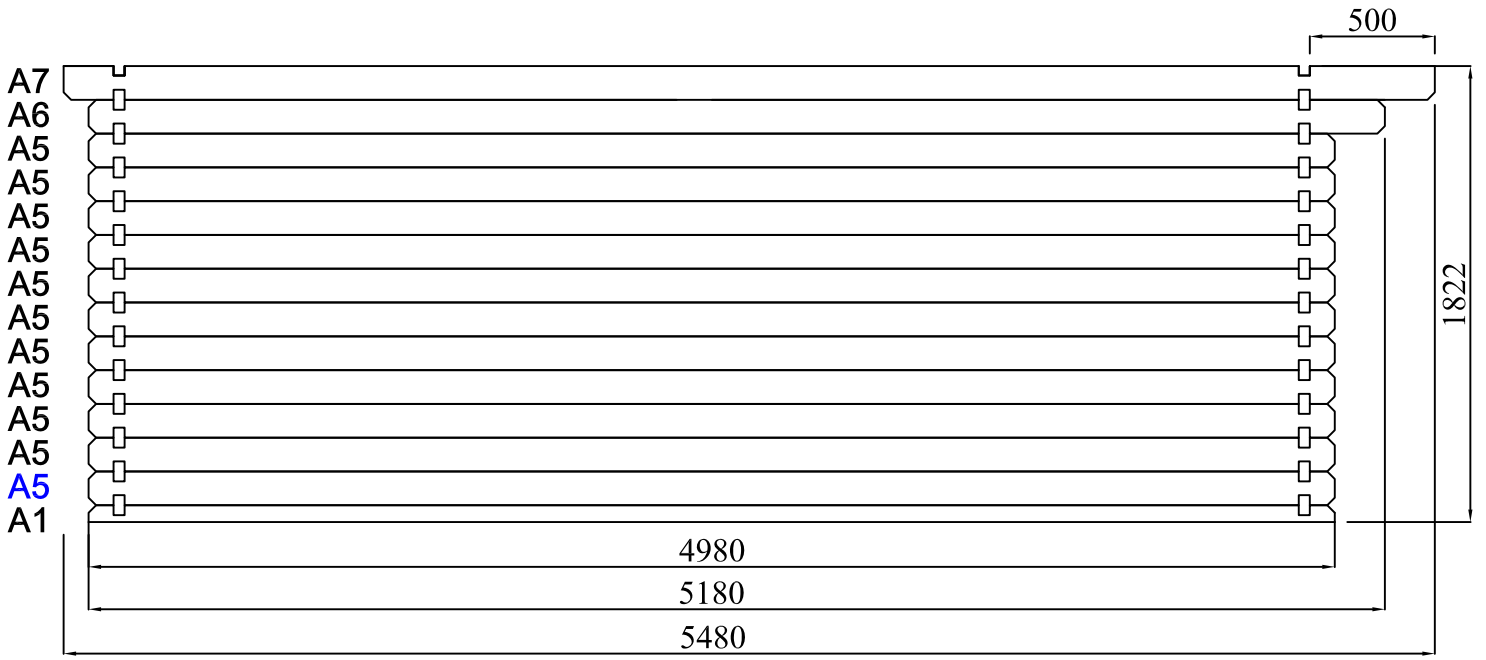



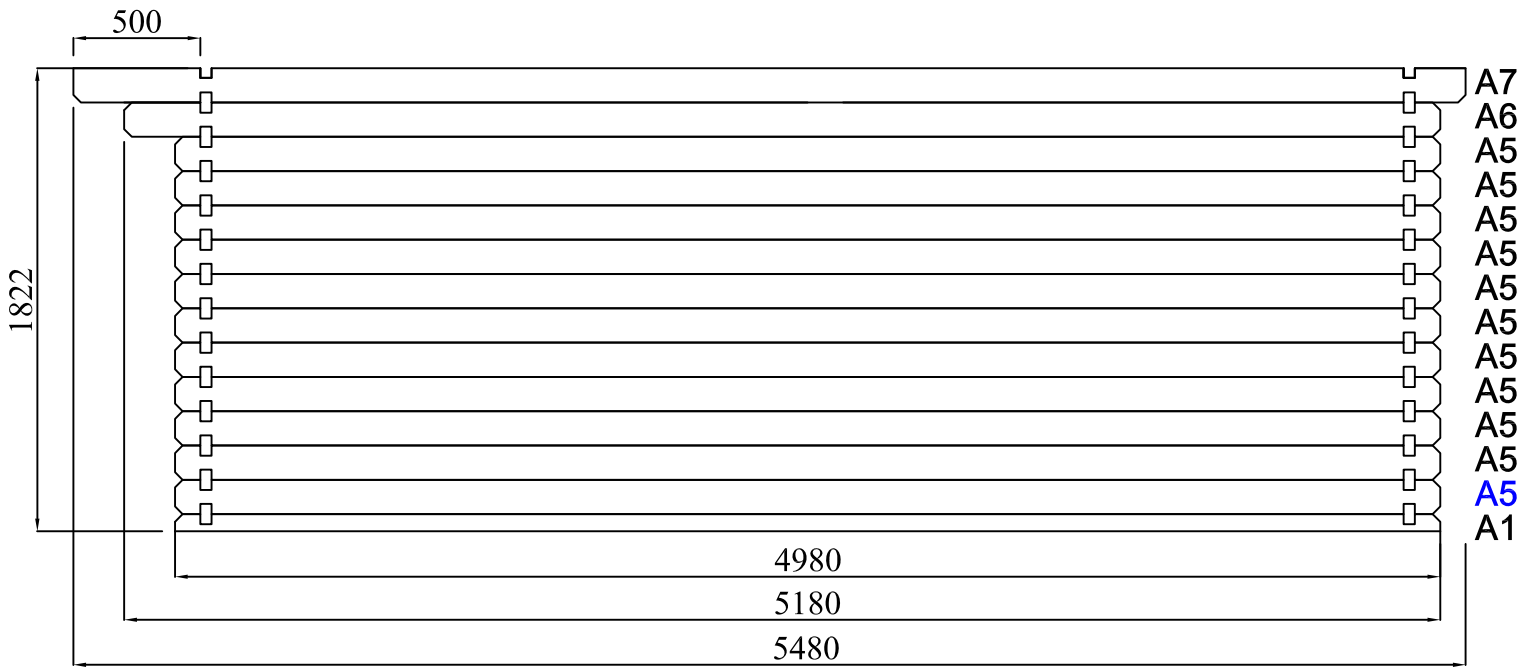



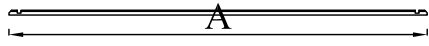
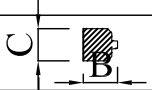
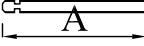
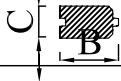
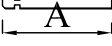

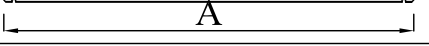

C

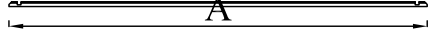

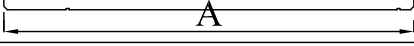
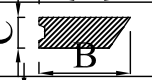

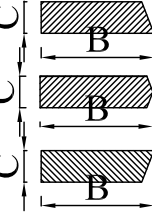
D

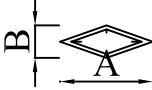
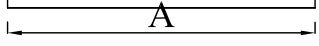
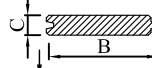
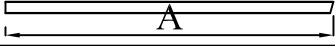

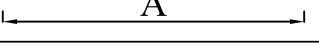
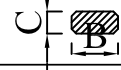
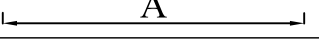
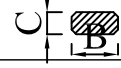
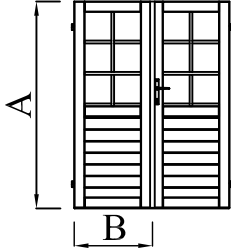
STÜCKLISTE

Nr.	Menge	Abmessungen, mm			Details	
		A	B	C		
A1	x 2	4980	67,5	44		
A2	x 12	1780	135	44		
A3	x 14	600	135	44		
A4	x 14	465	135	44		
A5	x 35+1	4980	135	44		
A6	2	5180	135	44		
A7	1+1	5480	135	44		
	2+1+2	5480	140	44		
	1+1	4980	540	44		
	x 2	220	100	19		
	126+2	2760	88	17		
	2+2	2830	120	19		
	6	1830	40	16		
	4	2740	60	19		
	1+1	1820	665	40		

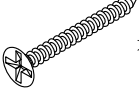
STÜCKLISTE

2 x 40 mm	4 x 40 mm	3 x 30mm	3 x 20 mm
 x 510	 x 62	 x 66	 x 12
5 x 70 mm			
 x 24			
		 x6	

Hinweis: Die Beträge in Klammern in dieser Liste aufgeführt sind zusätzliche Teile im Falle eines Elements diese Referenz wäre in Ihrem Paket beschädigt werden.